

NOTES:

1. CLASS 1 CONCRETE WITH DESIGN STRENGTH OF 4500 PSI AT 28 DAYS
2. REINFORCED WITH 6X6X6 WIRE MESH
3. JOINTS TO BE SEALED WITH RAM-NEK FLEXIBLE PLASTIC GASKETS
4. STRUCTURE PRODUCED IN ACCORDANCE WITH ASTM C-478

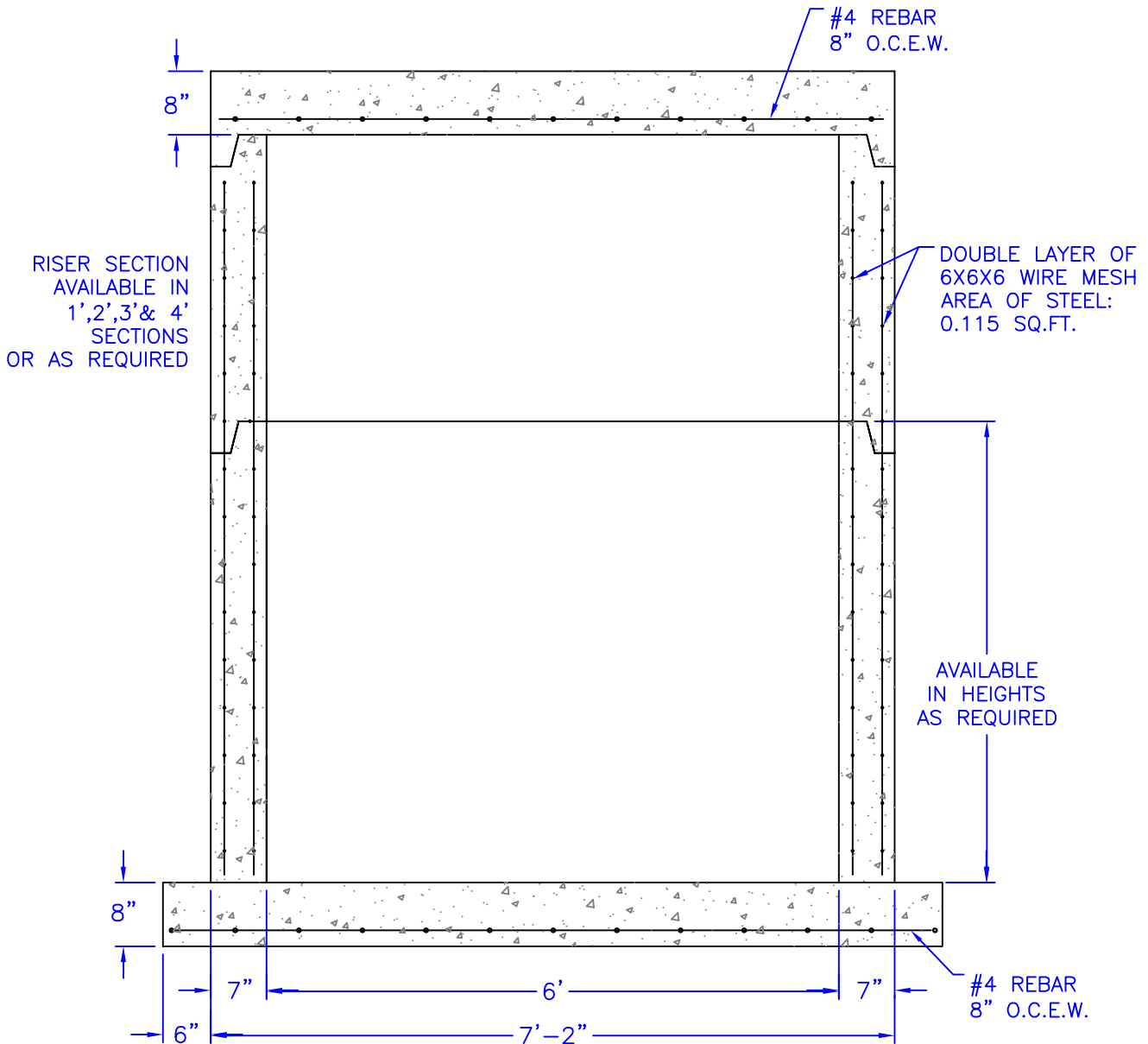

72" DIA. WET WELL (EXT BASE)

REINFORCEMENT DETAILS

12/18/09



28021 Coker-Vail Road
Phone (225) 567 - 2700

Holden, LA
Fax (225) 567 - 3089

www.gaineysconcrete.com